

INSTRUCTIONS FOR USE



















Sublime[™]
Guide Sheath

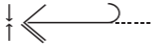

CAUTION: U.S. Federal law restricts this device to sale by or on the order of a physician (or properly licensed practitioner).

Explanation of possible symbols on product labeling:

 Contents: One (1) Guide Sheath	 Sterilized Using EO	 Ref Catalogue Number
 Do Not Reuse	 Non-pyrogenic	 Caution, Consult Accompanying Documents
<p>Rx only</p> Caution: U.S. Federal law restricts this device to sale by or on the order of a physician (or properly licensed practitioner).	 Use by Date	 Keep Dry
 Do Not Use if Package is Damaged	 Manufacturer	 Maximum Guidewire Diameter
 Keep Away From Heat	 Lot Number	 Effective Length
 Do Not Re-Sterilize	 Date of Manufacture	 Consult Instructions for Use

SURMODICS™ SUBLIME™ GUIDE SHEATH

CAUTION: U.S. Federal law restricts this device to sale by or on the order of a physician (or properly licensed practitioner).

DESCRIPTION

The Surmodics™ Sublime™ Guide Sheath is designed to perform as a guide sheath and/or introducer sheath. The sheath is braid reinforced with an embedded radiopaque marker band to identify the distal tip. It also has a hydrophilic coating over the working length to provide a lubricious surface to ease insertion. The device comes packaged with a dilator, which is either .018" or .035" guidewire compatible (Fig. 1).

INTENDED USE

The Sublime Guide Sheath is intended to introduce therapeutic or diagnostic devices into the vasculature, excluding the coronary and neuro vasculature.

COMPONENT DESCRIPTION

Refer to product labeling for appropriate system components.

All components that enter blood vessels are radiopaque.

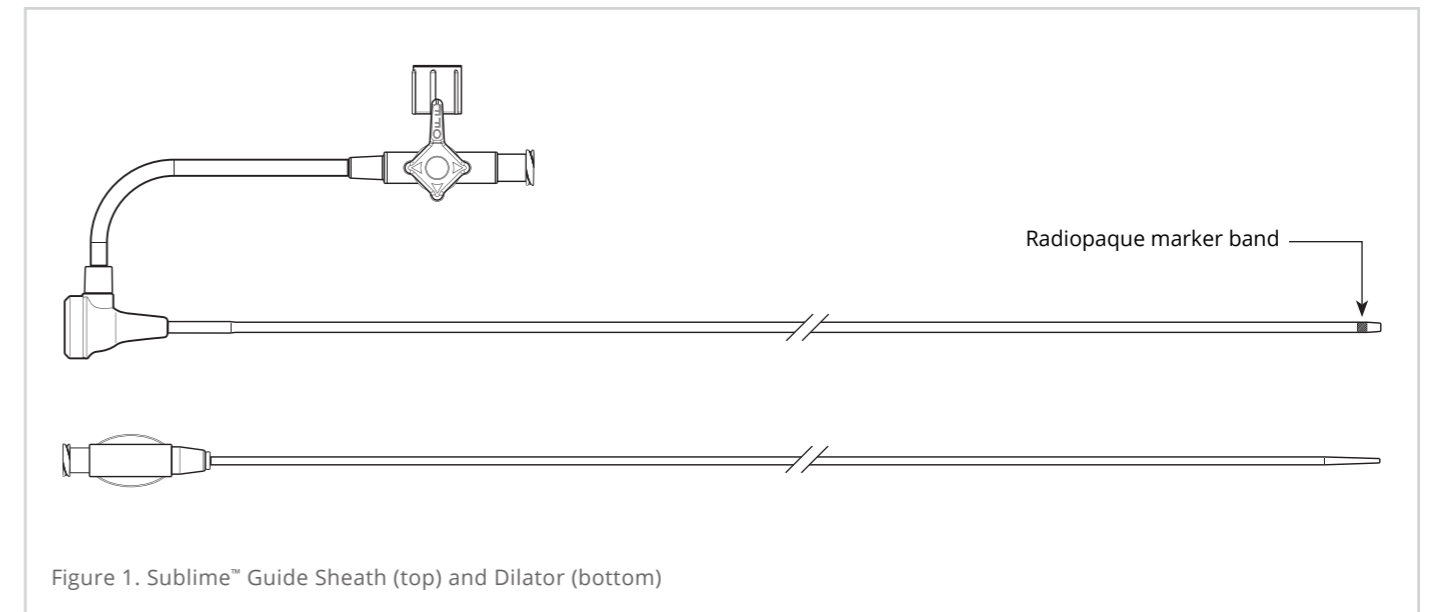

SHEATH

This highly flexible, braid reinforced sheath is designed to resist kinking and maximize strength while keeping a minimized profile. Incorporated in the sheath is a radiopaque marker band located approximately 5 mm from the distal tip (Fig. 2). The Sublime Guide Sheath has an atraumatic tip and has a hydrophilic coating over the working length.

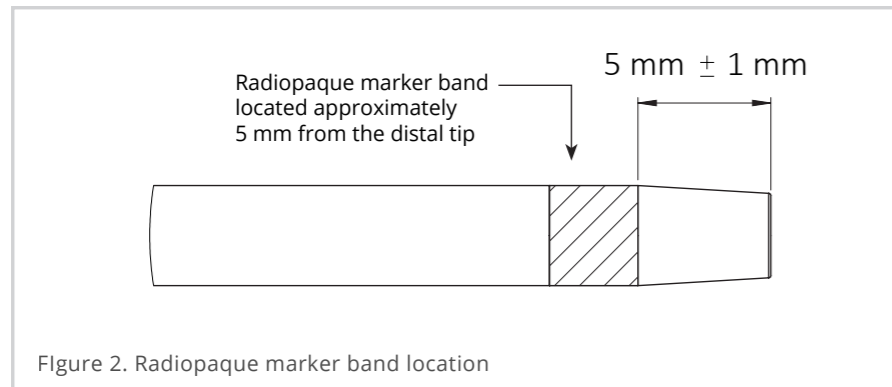

Figure 2. Radiopaque marker band location

DILATOR

The dilator hub is designed to snap into the Sublime Guide Sheath cross cut valve cap. Additionally, the dilator shaft design allows for simultaneous movement of the sheath and dilator assembly. The dilator features an atraumatic tip, which is designed to extend beyond the sheath tip by approximately 5 cm. The dilator shaft is radiopaque.

CROSS CUT VALVE

The Sublime Guide Sheath features a custom designed cross cut valve (CCV) that is integrated into the sheath hub and includes a 3-way stopcock with sidearm extension tubing. No assembly is required.

CONTRAINDICATIONS

None known.

COMPLICATIONS/POTENTIAL ADVERSE EVENTS

Possible complications associated with catheterization include, but are not limited to, the following:

- Bleeding complications
- Infection and pain at puncture site
- Distal embolization
- Hematoma
- Femoral pseudoaneurysm/ Pseudoaneurysm formation
- Arterial occlusion
- Intra-vessel thrombosis
- Arterial injury/perforation/dissection
- Arterial spasm
- Arterial embolism/occlusion
- Hemorrhage and hemorrhagic shock

WARNINGS

- Before withdrawing the sheath from the body, insert the dilator to avoid possible breakage.

PRECAUTIONS

- Prior to beginning radial artery access, an assessment such as the Allen's test should be performed to assess the presence/adequacy of dual arterial circulation to the hand.
- This product is intended for use by physicians trained and experienced in diagnostic and therapeutic techniques. Standard techniques for placement of vascular access sheaths should be employed.
- Intended for one-time use. Do not reuse. Do not re-sterilize.
- Before use, ensure the maximum diameter of the therapeutic or diagnostic device to be used is appropriate for the sheath size being used. All devices used with the Sublime Guide Sheath should move freely through the valve and sheath. Damage to the sheath may occur if the fit is too tight.
- Do not use if the package or product is damaged or altered in any way.
- Do not use agents containing organic solvents or oleosus contrast medium directly on this product.
- Do not wipe the surface with chemical solution such as alcohol.
- When puncturing, suturing or incising the tissue near the sheath take care to avoid damaging the sheath.
- When inserting, removing, or manipulating a device within the sheath always maintain sheath position.
- Before removing or inserting devices through the sheath, aspirate through the 3-way stopcock to clear the sheath, then flush with heparinized saline.
- The entire procedure, from skin incision to sheath removal, must be carried out aseptically.
- Do not use a power injector through the 3-way stopcock. Excessive leakage may occur through the CCV.
- When applying torque to the sheath the dilator and/or a guidewire must be inserted.
- When inflating a balloon at, or close to, the sheath tip, ensure the balloon is not inside the distal tip of the introducer. The radiopaque band is approximately 5 mm from the distal tip and does not mark the true distal tip of the device (Fig. 3).

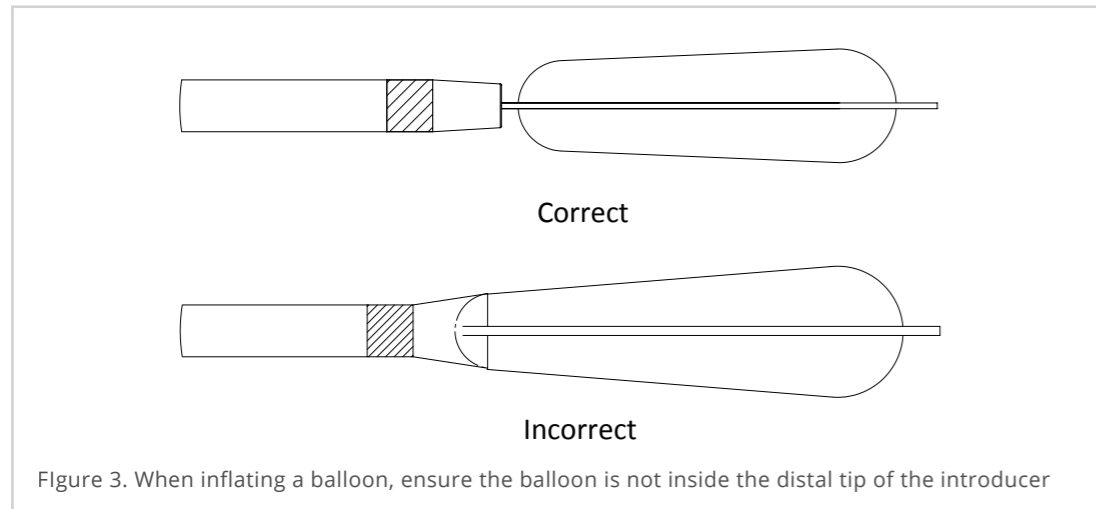

- Do not attempt to withdraw or insert the dilator or sheath if resistance is met.
- Do not heat or bend the sheath tip. Damage to the sheath may result.
- Do not rapidly and/or forcibly advance or insert the dilator, guidewire or other devices if the sheath is folded, bent or distorted.

INSTRUCTIONS FOR USE

SHEATH INTRODUCTION

1. Upon removal from packaging ensure the inner diameter (I.D.) of the sheath is appropriate for the maximum diameter of the device to be introduced.
2. Using 3-way stopcock, flush the sheath by completely filling with heparinized saline, removing all air from assembly. If desired, connect a flushing line to the 3-way stopcock of the Sublime Guide Sheath.
3. Flush the dilator with heparinized saline.
4. Insert the dilator tip into center of CCV.
NOTE: Be sure to insert the dilator into the center of the CCV. Forcibly inserting dilator, which misses the center of the CCV, may cause damage to dilator and/or valve assembly and result in blood leakage.
5. Completely insert dilator into sheath. The dilator hub will snap into the cap of the CCV assembly (Fig. 4).

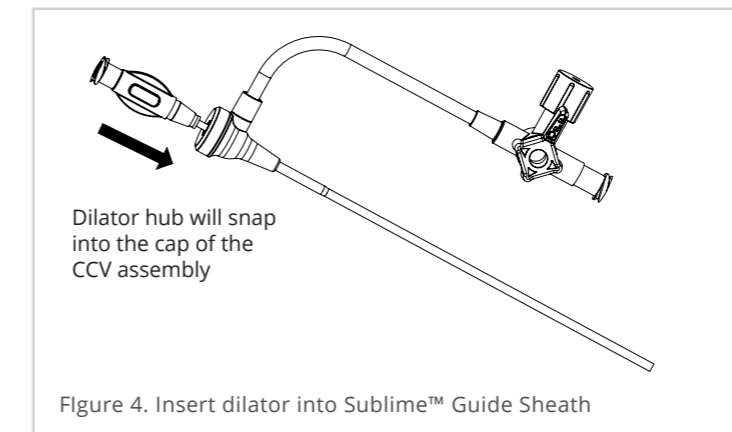

NOTE: Ensure dilator hub is secured into CCV assembly. If it is not secure, the sheath may advance without the dilator during insertion causing damage to the sheath tip or to the vessel. Advancing the sheath alone may damage the vessel.

NOTE: To “unlock” the dilator from the CCV and sheath, sideload or bend the dilator hub downward to unsnap it (Fig. 5).

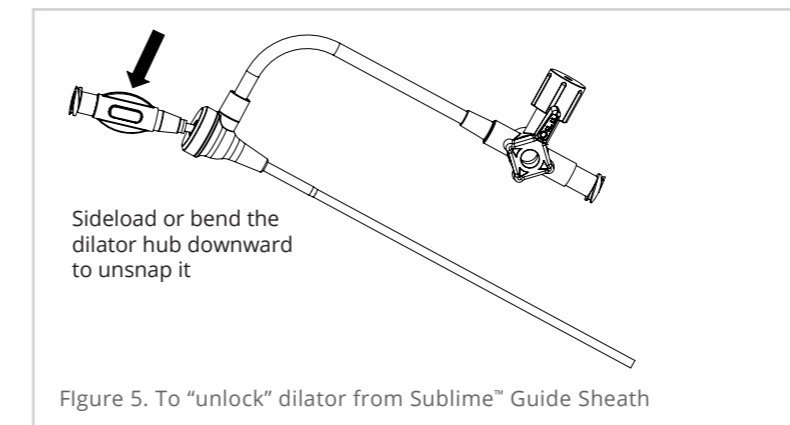

6. Activate hydrophilic coating by wetting the distal portion of the sheath with heparinized saline as needed.
NOTE: For best results maintain wetted condition throughout placement for the full length of the sheath.
7. Access the vessel using the appropriate technique.
8. Once the guidewire is in place in the vessel, insert the dilator/sheath assembly over the guidewire and advance it to the desired target location.
9. While holding the sheath CCV hub, slowly remove the dilator leaving the sheath in the vessel. If injection or sampling is necessary at this point, remove the guidewire only and use the dilator hub as an injection port before removing it.

10. As needed, aspirate and flush the sheath using the 3-way stopcock.
11. The radiopaque marker band will identify the sheath tip location under fluoroscopy. It is located approximately 5 mm proximal to the sheath tip.
12. The side tube may also be used as a continuous infusion site by connecting an infusion line to the 3-way stopcock.
13. Insert appropriately sized interventional/diagnostic device through the sheath and into the blood vessel, then advance it to the desired location.

SHEATH REMOVAL

1. After the intended procedure is completed, remove the inserted devices from the sheath while holding the sheath CCV hub in place.
2. Insert guidewire at least 10 cm past the tip of the sheath.
3. Insert the flushed dilator over the wire into the sheath and snap into CCV assembly hub.
4. Withdraw the sheath and dilator as an assembly; the guidewire may also be removed with sheath/dilator assembly.
5. Remove the guidewire from the vessel if desired.
6. After use, the Sublime™ Guide Sheath may be a potential biohazard. Handle and dispose the product in accordance with acceptable medical practices and applicable local, state, and federal laws and regulations.

HOW SUPPLIED

Supplied sterilized by ethylene oxide gas in a peel-open pouch. Intended for one-time use. Do not reuse. Do not re-sterilize. Sterile if package is unopened and undamaged. Do not use the product if there is doubt as to whether it is sterile or not. Store in a cool, dark, dry place. Avoid extended exposure to light. Upon removal from package, inspect the product to ensure no damage has occurred.

REFERENCES

These instructions for use are based on experience from physicians and (or) their published literature. Refer to your local Surmodics Sales representative for information available on literature.

EXPIRATION DATE

The expiration date is indicated on the label of the product package.

CONTENTS

One (1) product per package.

This page is intentionally left blank

This page is intentionally left blank

This page is intentionally left blank

This page is intentionally left blank

This page is intentionally left blank

This page is intentionally left blank

This page is intentionally left blank

This page is intentionally left blank

This page is intentionally left blank

This page is intentionally left blank

This page is intentionally left blank

This page is intentionally left blank

This page is intentionally left blank

This page is intentionally left blank

This page is intentionally left blank

This page is intentionally left blank

This page is intentionally left blank

This page is intentionally left blank



Made in
Ireland

Manufactured by:

Creagh Medical Ltd.
IDA Business Park
Ballinasloe, Co. Galway
H53 K8P4
Ireland
Phone +353-90-9646300

Manufactured for:

Surmodics, Inc.
7905 Golden Triangle Drive, Ste 190
Eden Prairie, MN 55344 USA
Phone +1 952-500-7000
www.surmodics.com

CAUTION: U.S. Federal law restricts this device to sale by or on the order of a physician (or properly licensed practitioner).

SURMODICS, SUBLIME and the SURMODICS and SUBLIME logos are trademarks of Surmodics, Inc. and/or its affiliates.

www.surmodics.com/patents

© 2022 Surmodics, Inc. All rights reserved. PG-80619 r03

